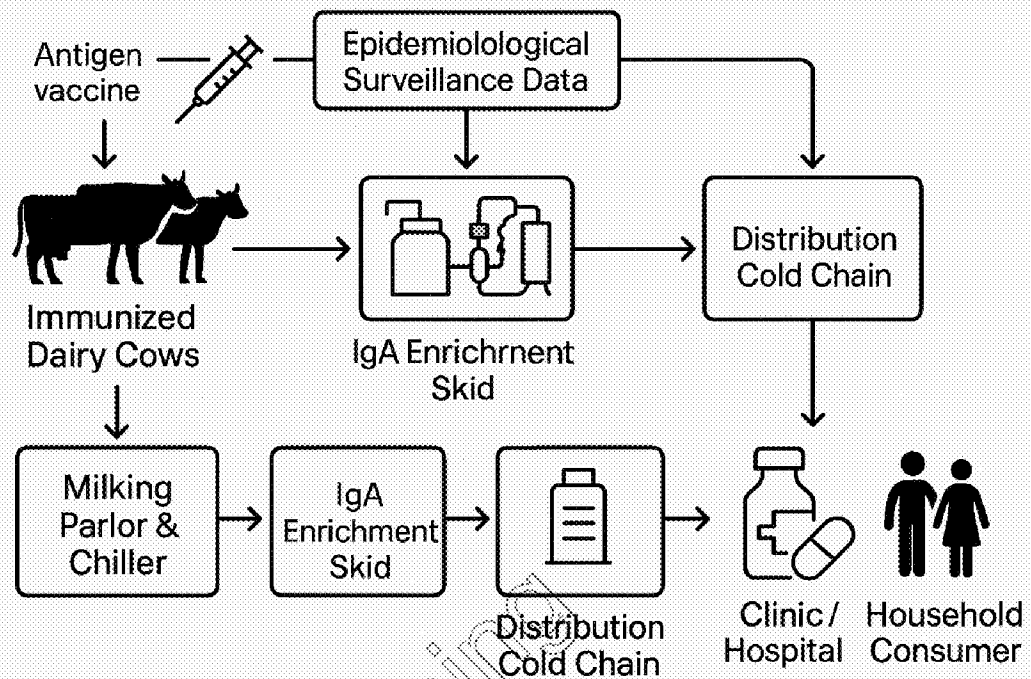

Fig. 1 – IgA Milk Production & Usage System



Pending processing

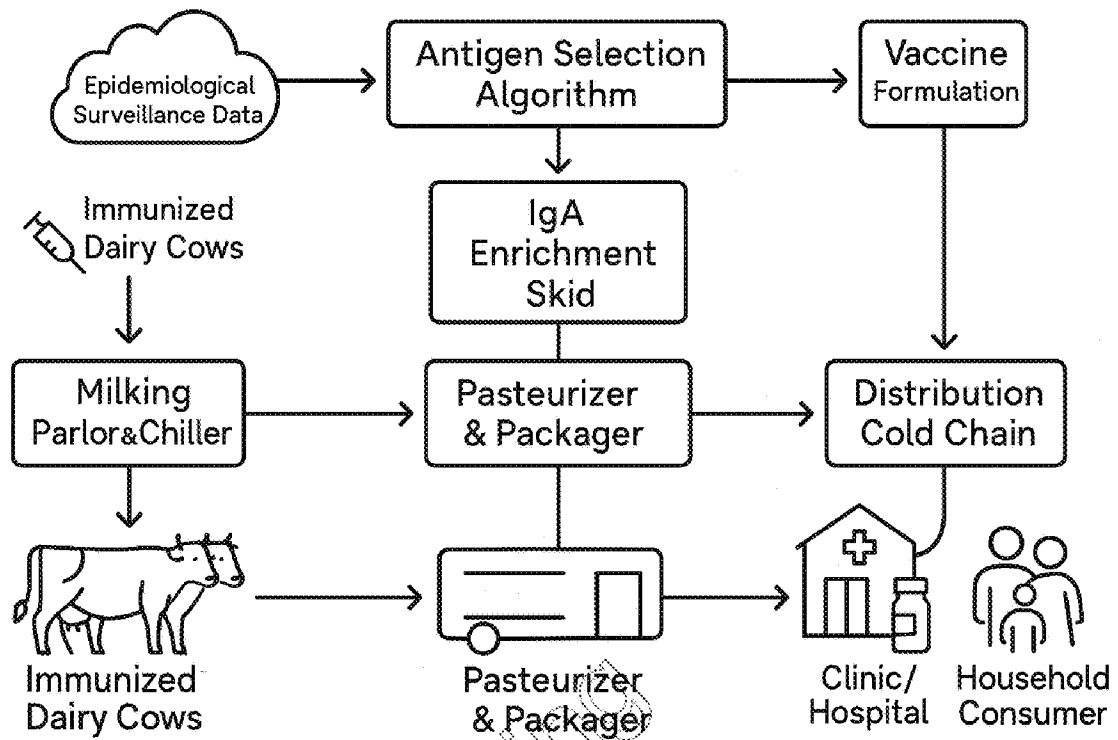

Fig. 1 — IgA Milk Production & Usage System

Pending processing

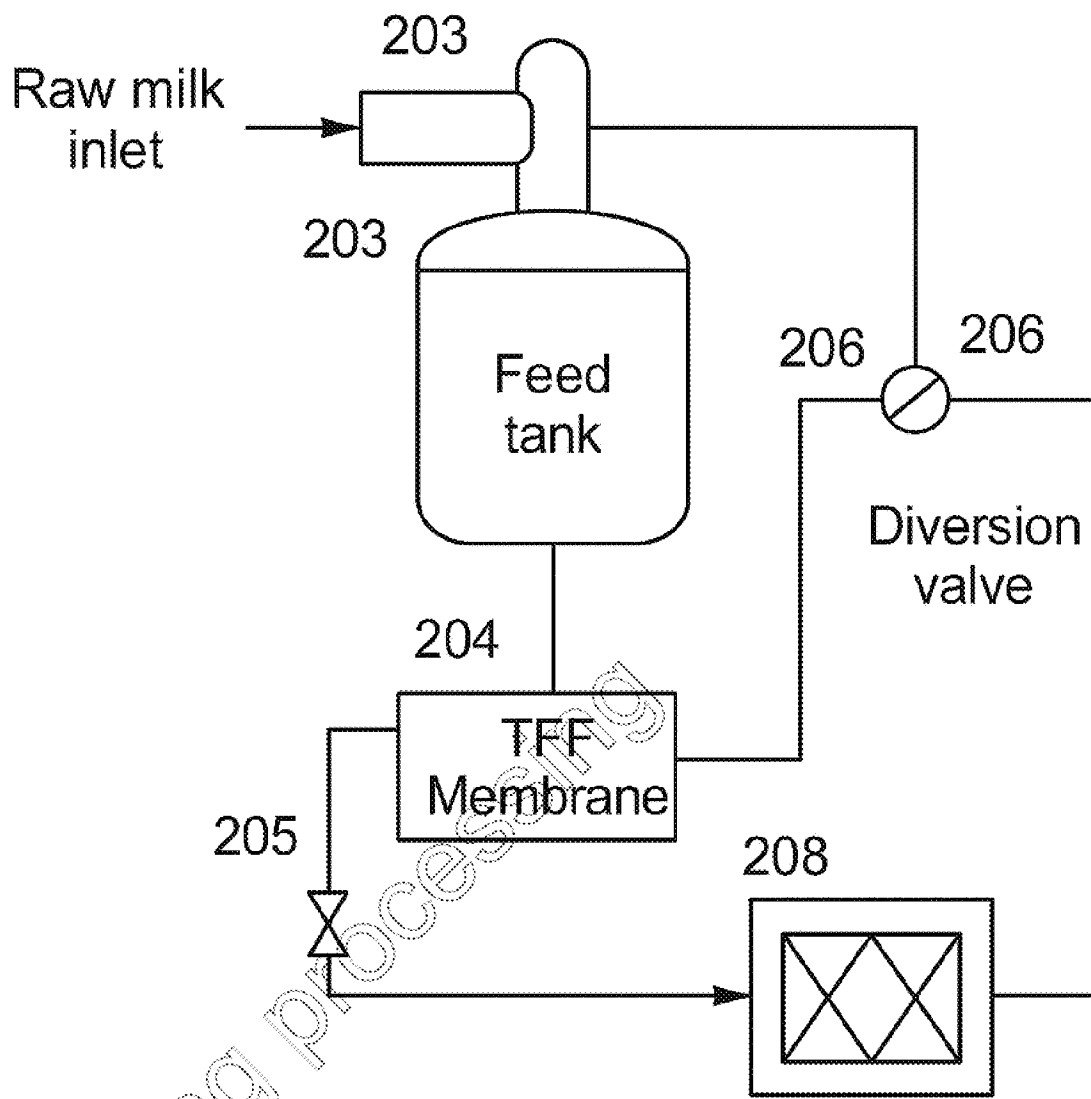

Fig. 2 – Continuous-flow IgA enrichment skid

Fig. 3

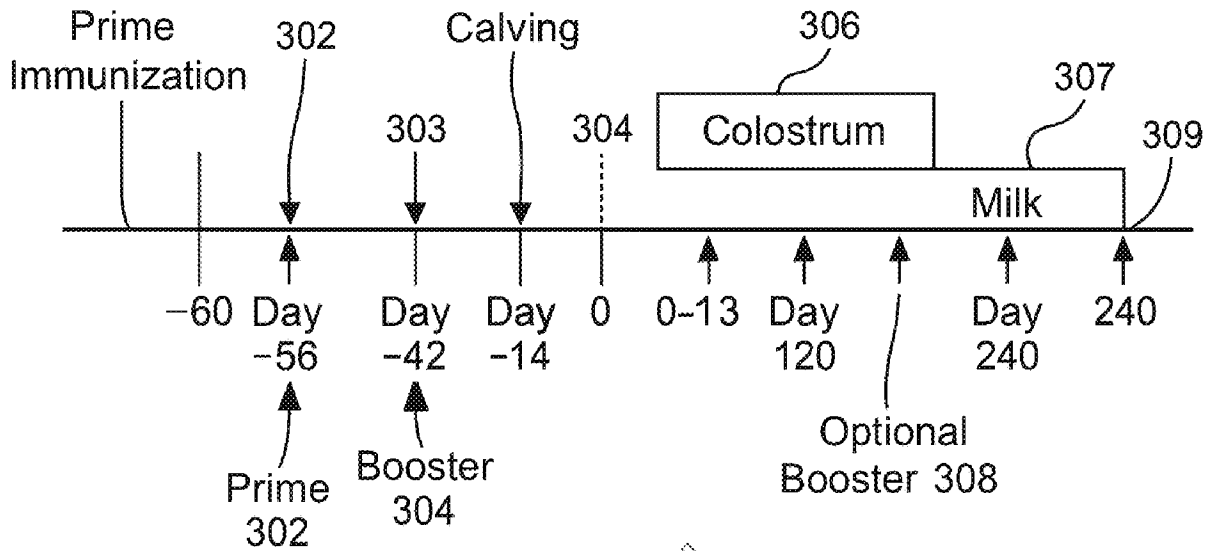

Fig. 3 – Bovine immunization schedule relative to calving.

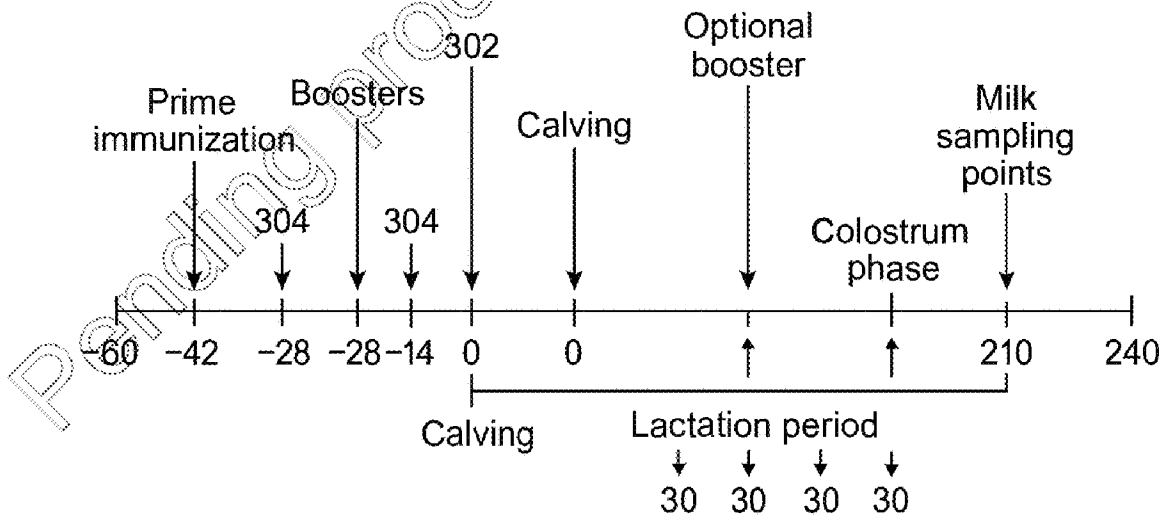

Fig. 3 – Bovine immunization schedule relative to calving

Pending processing

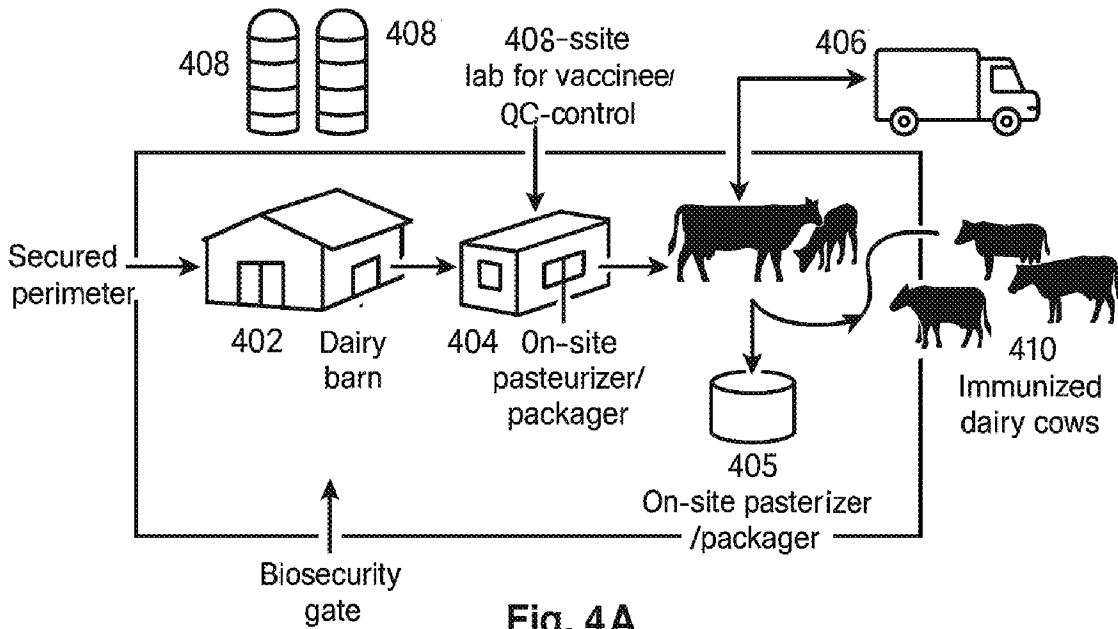

Fig. 4A

Dedicated company-owned farm implementation model

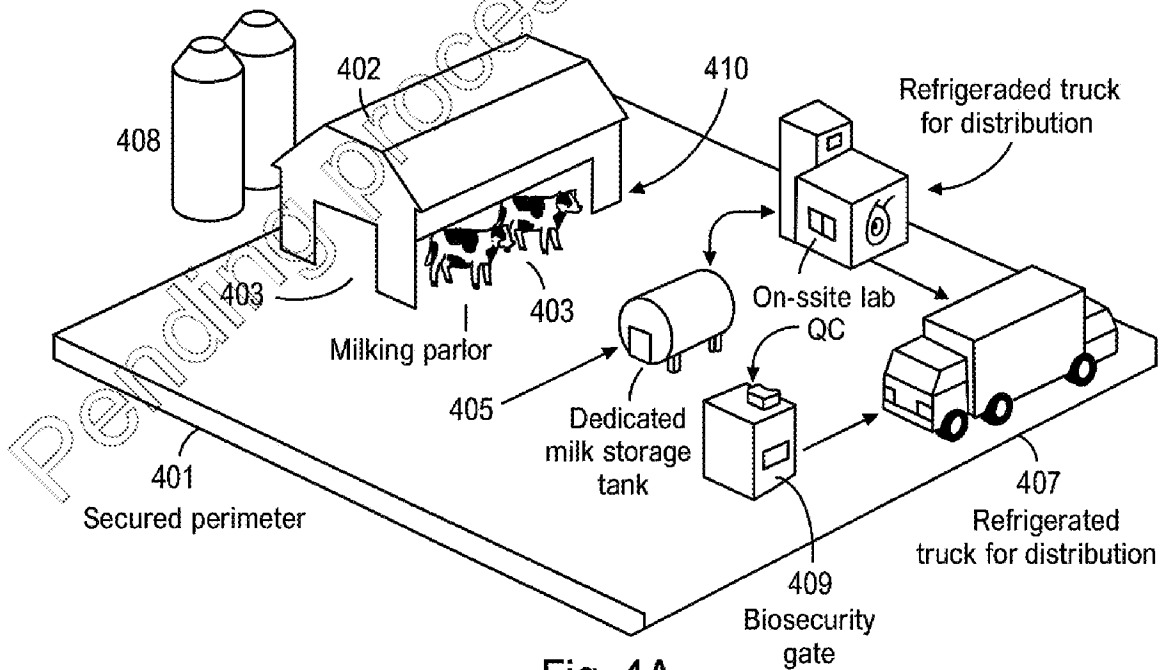

Fig. 4A

Dedicated company-owned farm implementation model

Pending processing

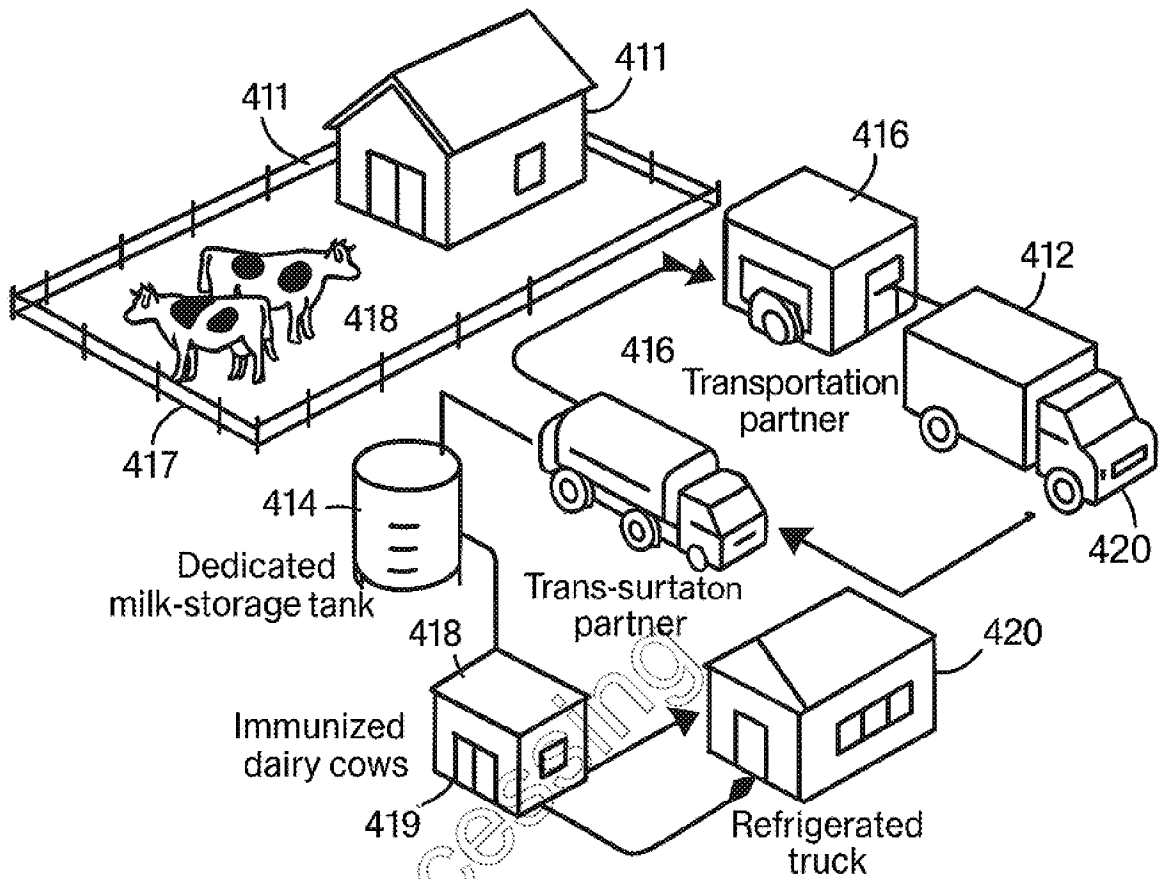

FIG. 4B

Partner farm implementation model

Pending process

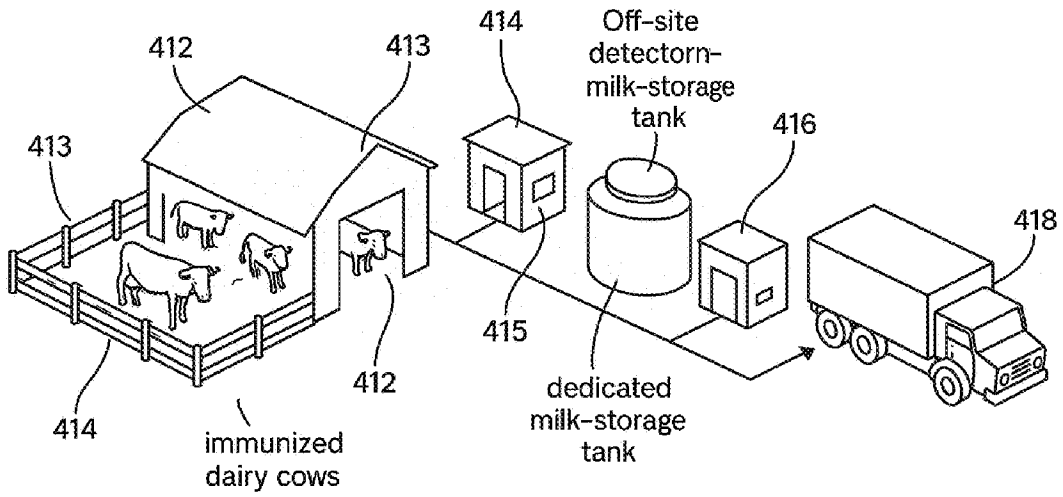
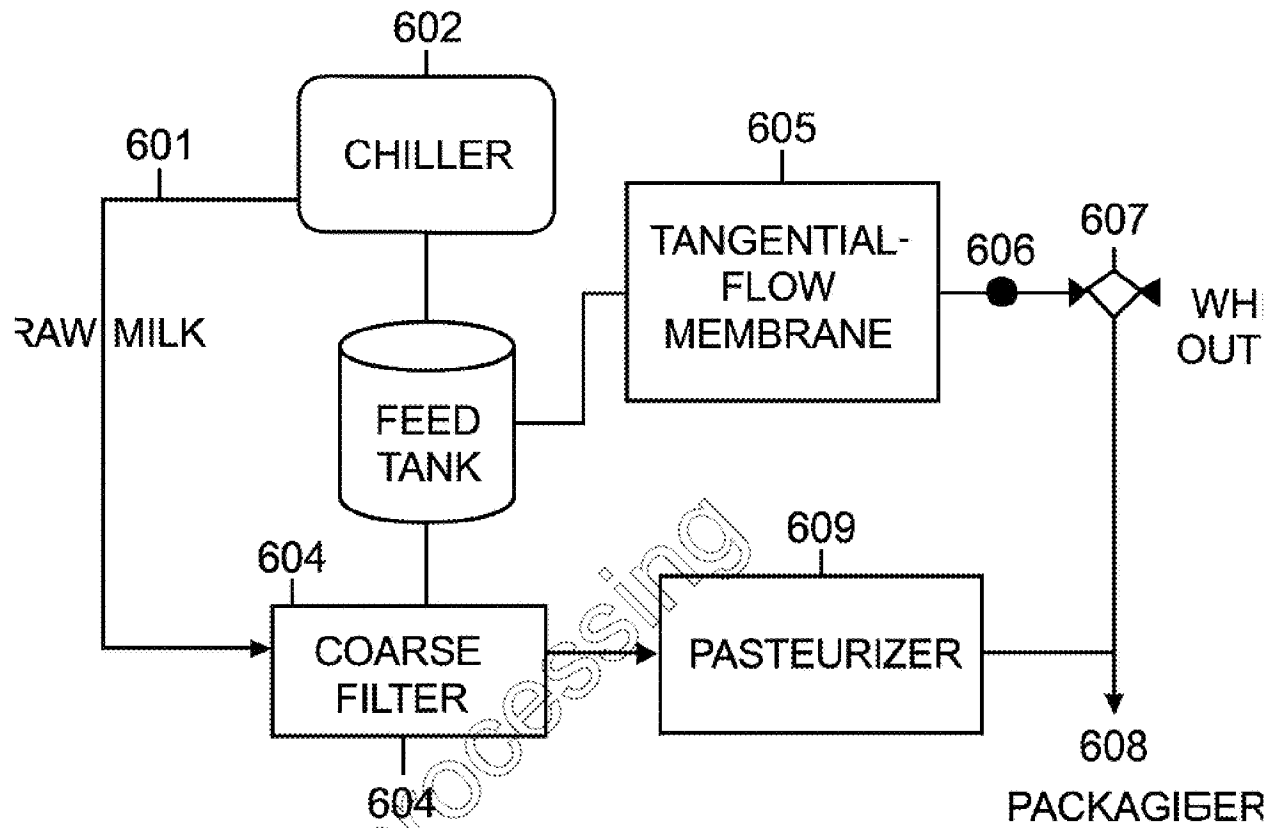

Fig. 4B

Partner farm implementation model

Pending processing

FIG. X



Pending processing