

Figure 1
Sensor-Integrated Skid Modules
for Inline Detection

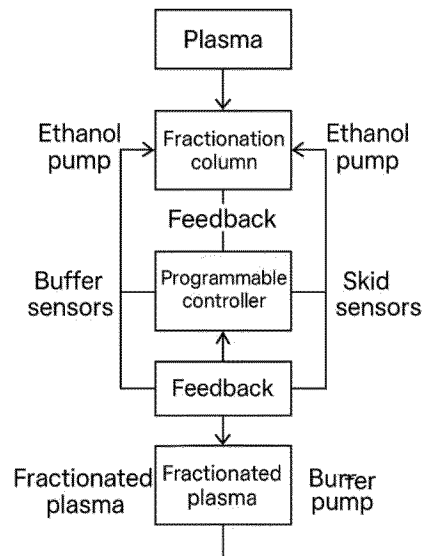

Figure 2
Batch Execution and
Sensor Feedback Flowchart

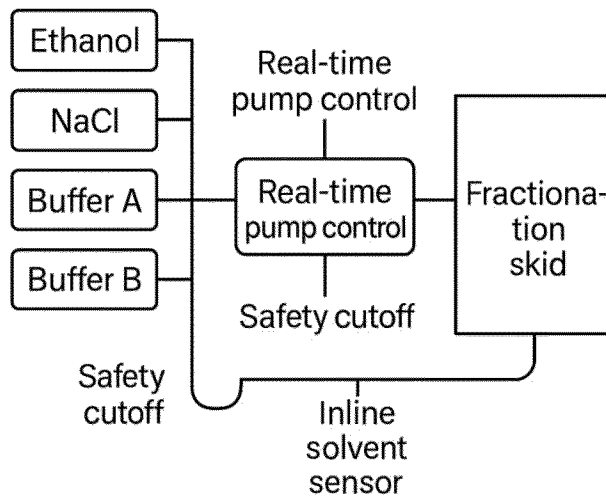

Figure 3
Modular Ethanol and Buffer
Dosing Pumps System

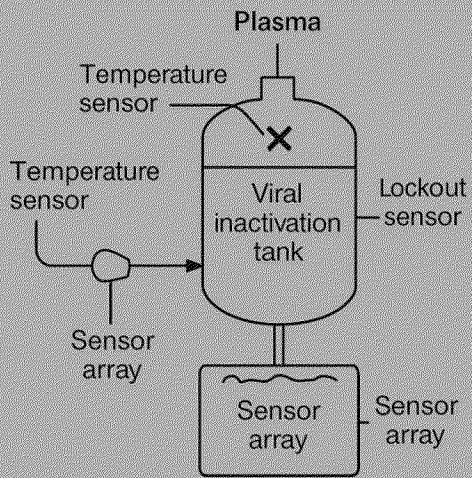

Figure A
 Fractionation Skid with
 Ethanol & pH Control Lo
 op

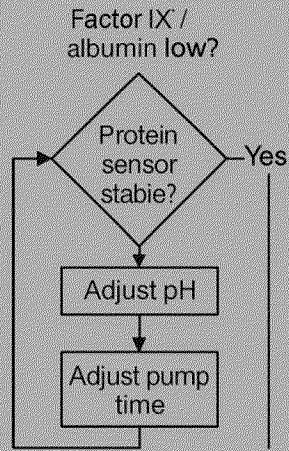

Figure B
 Sensor-Response
 Cascade Flowchart

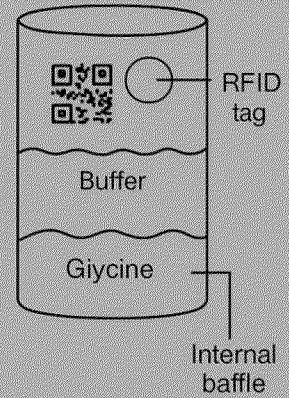

Figure C
 Buffer Cartridge
 with QR/RFID
 Safety System

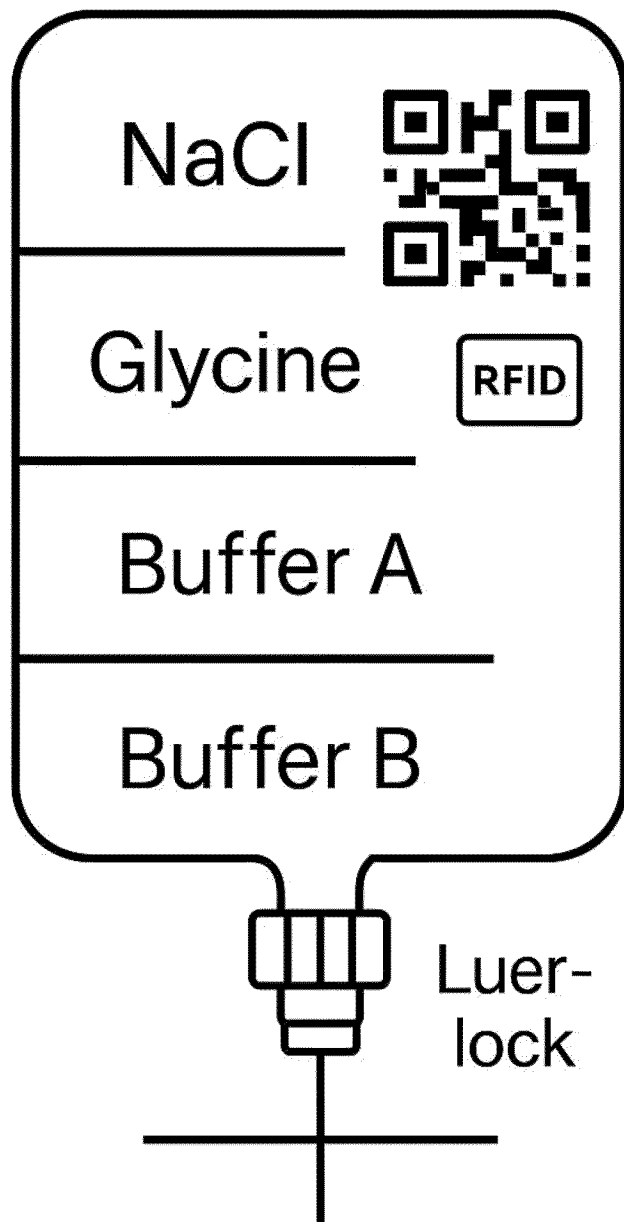

Figure C
Buffer Cartridge System
w/ QR/RFID Safety System

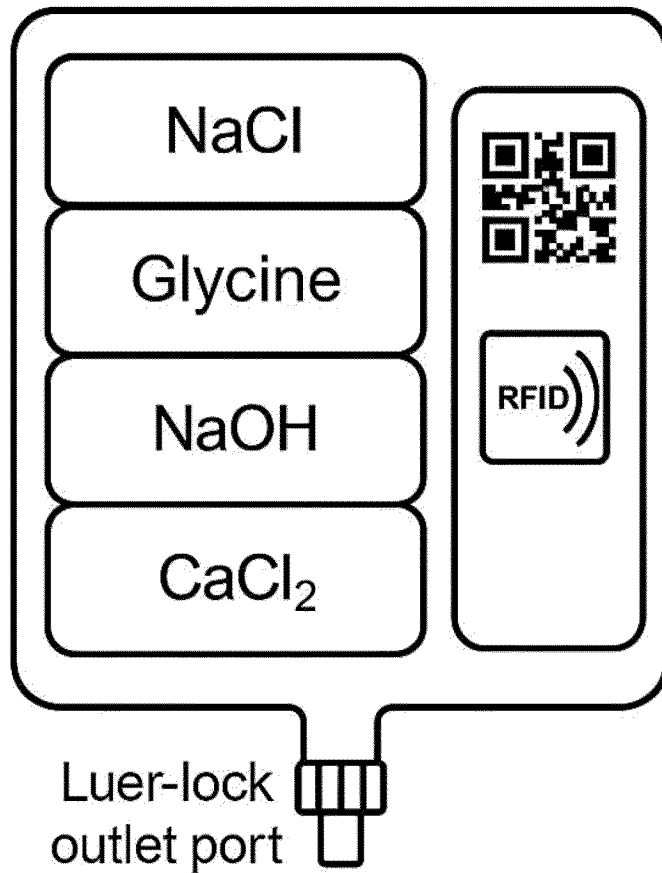

Figure C
Buffer Cartridge System w/
QR-RFID Safety System

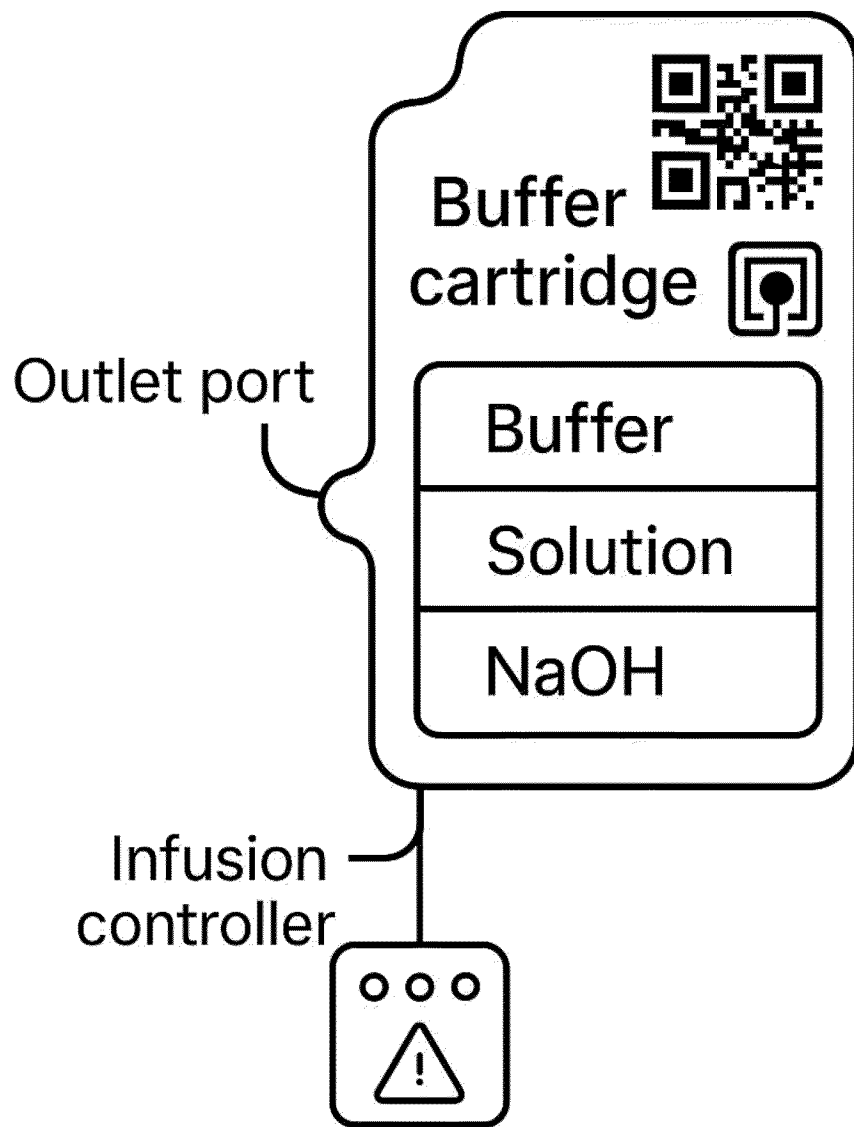

Figure C
Buffer Cartridge System with
QR-RFID Safety System

FIGURE D: Cloud Logic Tree for Protocol Management

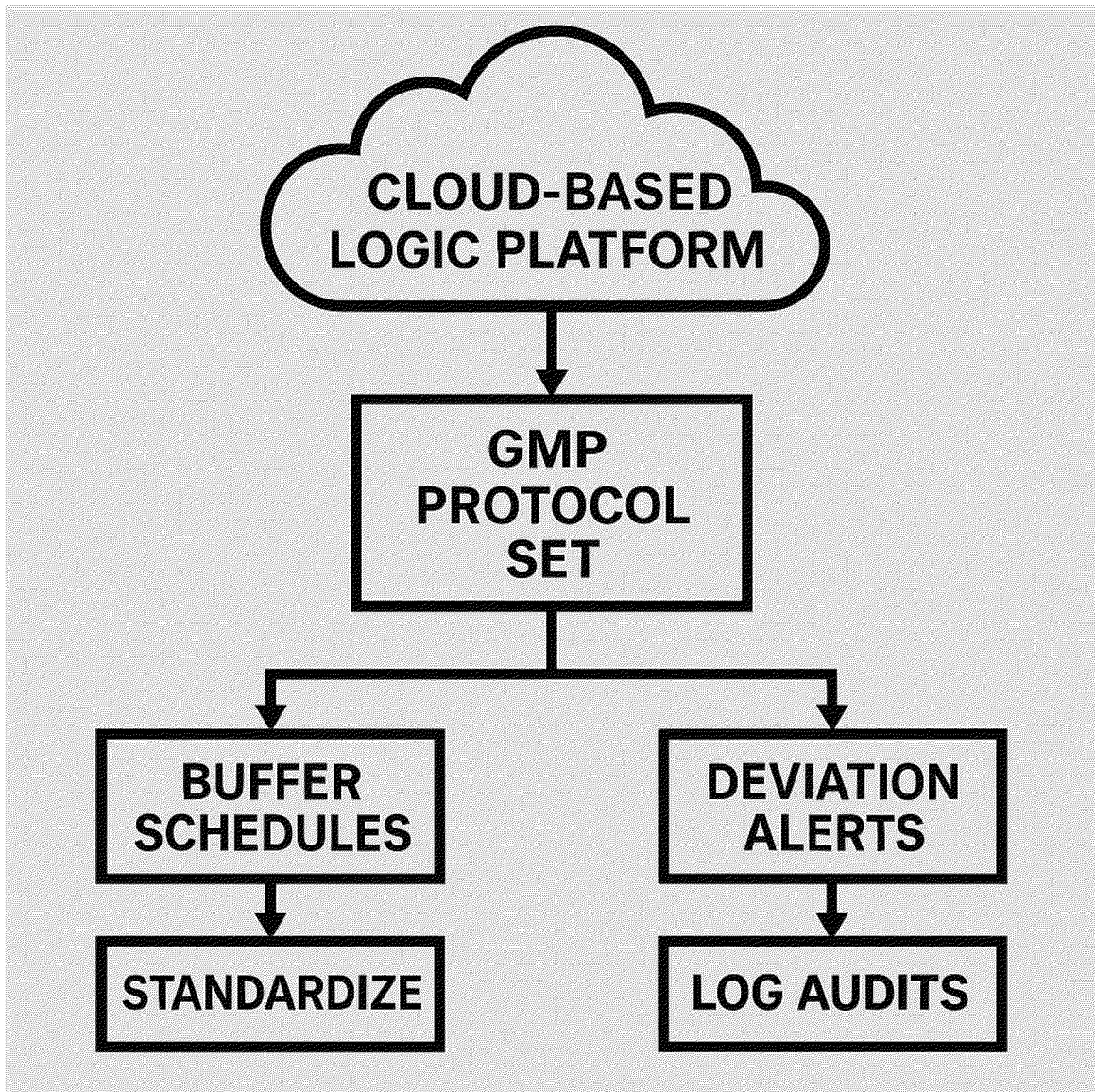
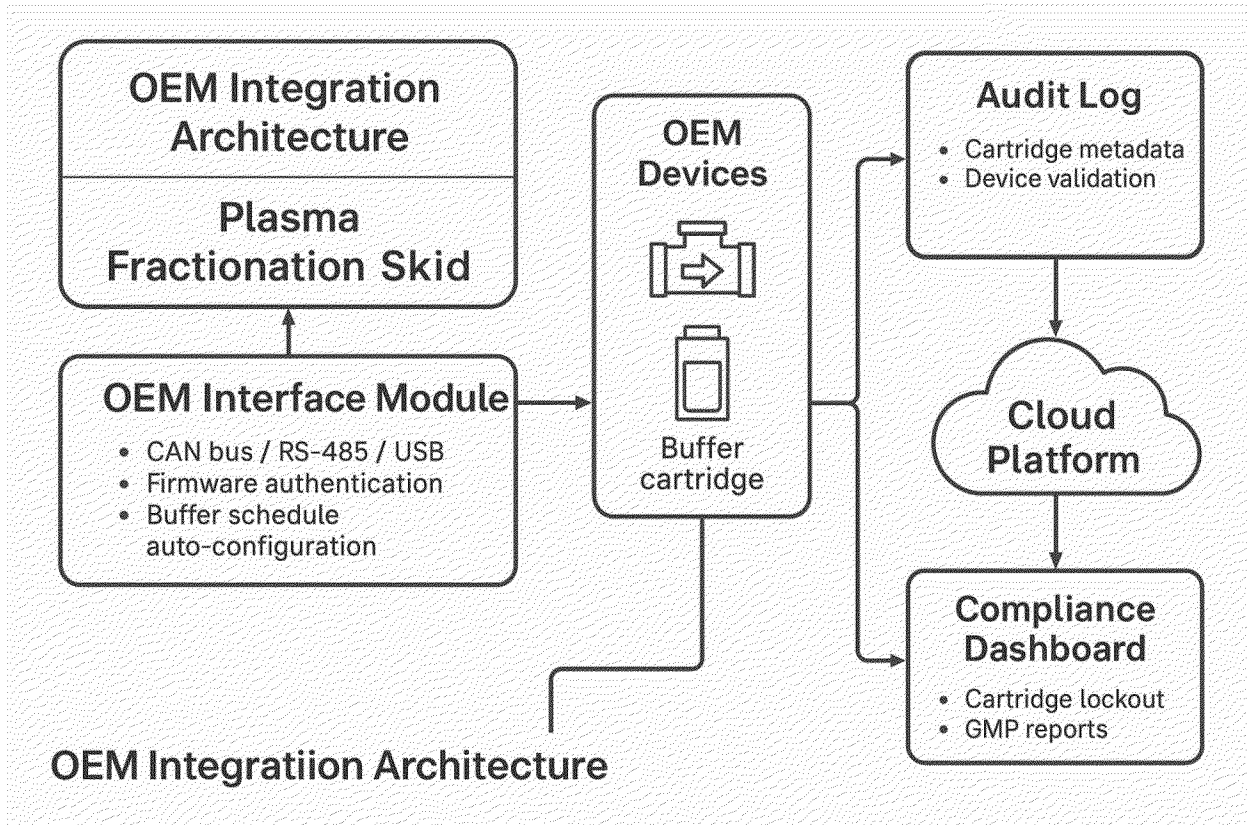

FIGURE 4: OEM Integration Architecture for Plasma Fractionation



• FIGURE : Cartridge Metadata Flow Diagram

